



PART NAME

PLASTIC INTERNAL PANEL

PART No.

PTX-25340-P

REVISION DATE

11-5-15

**DRAWING FOR REFERENCE**  
WE RESERVE THE RIGHT TO MAKE CHANGES TO OUR STANDARD PRODUCTS. PLEASE CONSULT WITH BUD INDUSTRIES PRIOR TO USING THIS DRAWING FOR DESIGN PURPOSE.

MATERIAL: ABS  
COLOR: LIGHT GRAY  
DIMENSIONS ARE INCH [MM]

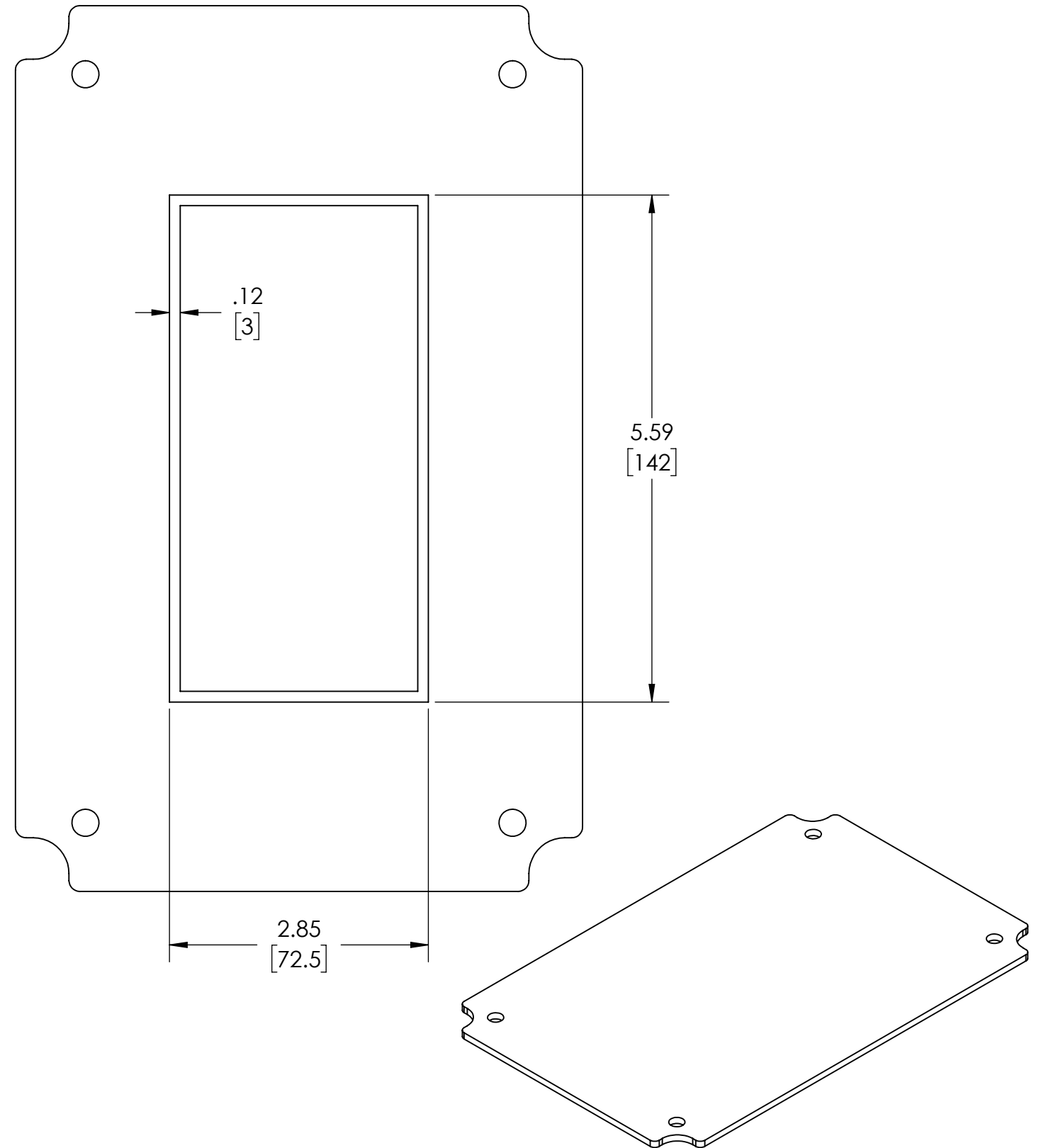
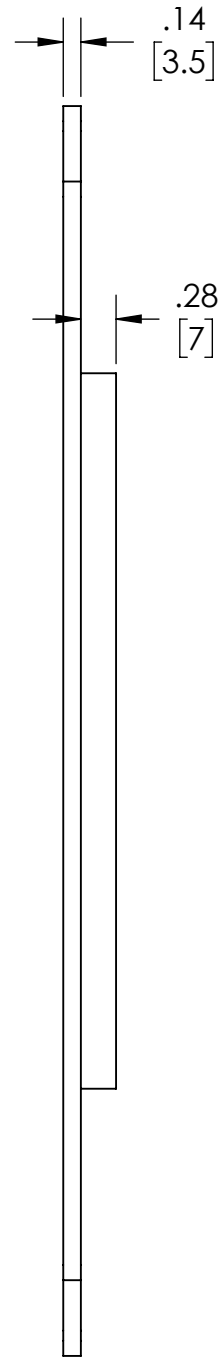
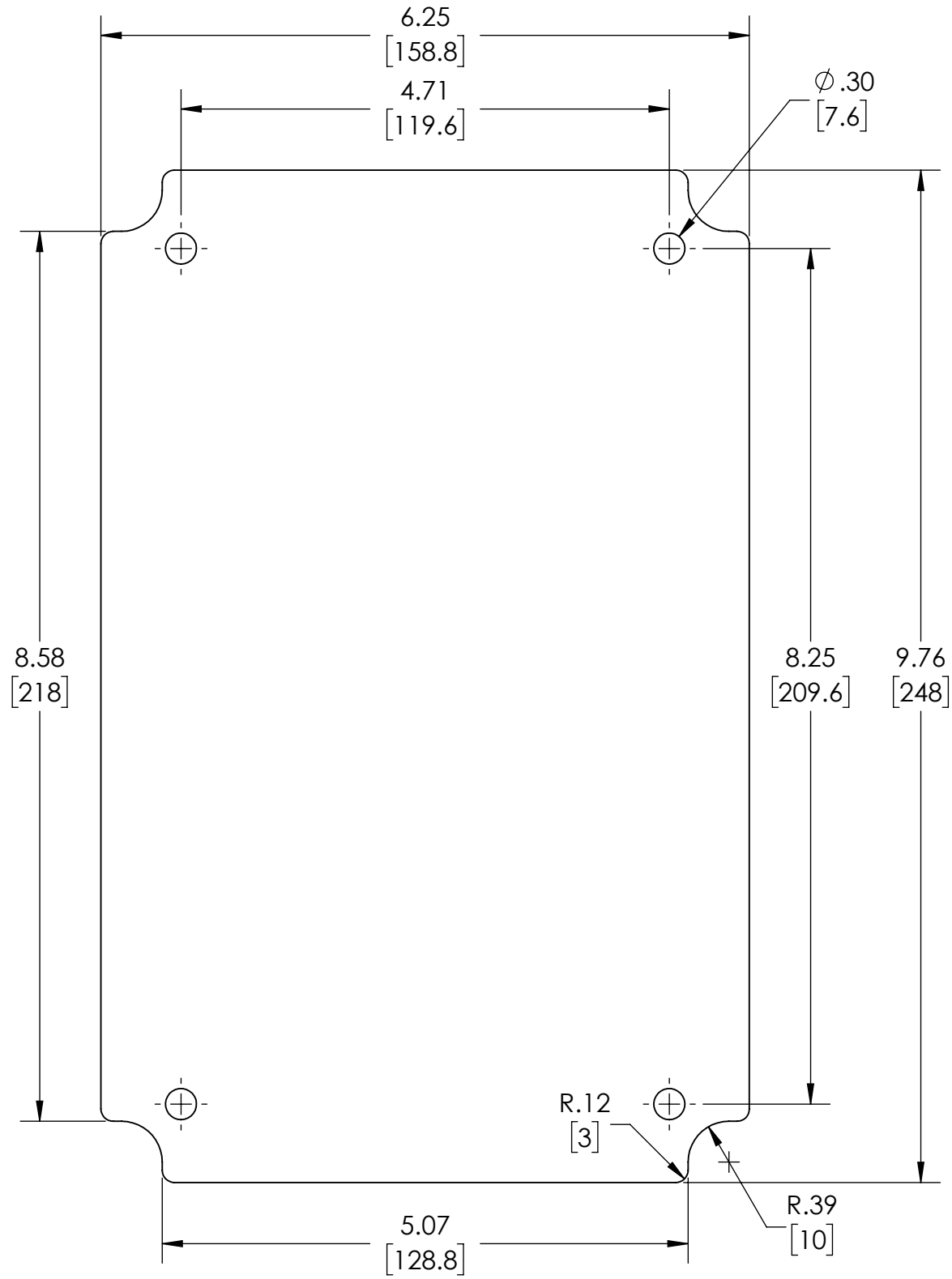

PANEL FITS ENCLOSURE: #PTS-25340 & #PTS-25340-C  
(MOUNTING HARDWARE SUPPLIED WITH ENCLOSURE)